

# SHARS MultiLock Toolholders Combination Type

APPLICATION: Can be used with pin-lock only, pinlock & clamp, or clamp only, depending on the insert style used.

FEATURES: Accept these triangular inserts: Page 38  
TNMX, TNMZ, TNMM, TNMA, TNMG, TNMP, TNG, TNU

## MTAN Toolholders

APPLICATION:

FEATURES:

- For turning & facing
- Negative rake.
- 0° end cutting edge angle.

Shank Square	OAL	Insert I.C. T	Model #	Finger Clamp #	Locking Pins #	Shims #	Right Hand Order #	Left Hand Order #	USA Brand	SHARS (D)
1/2"	4"	1/4" 1/8"	MTAN R/L-08-2A	CL-6	M-ZX0410		404-1500	404-1504	\$43.15	<b>\$23.95</b>
5/8	4-1/2	3/8 1/8	MTAN R/L-10-3B*	CL-6	NL-0414	T1603B	404-1501	404-1505	48.10	<b>26.95</b>
3/4	4-1/2	3/8 1/8	MTAN R/L-12-3B*	CL-6	NL-0414	T1603B	404-1502	404-1506	54.75	<b>30.95</b>
1	6	1/2 3/16	MTAN R/L-16-4D	CL-12	NL-0617	T2203B	404-1503	404-1507	58.25	<b>32.95</b>

\*To accept 3/16" thick inserts, order 1/8" thick shims

Insert on page 64



## MTFN Toolholders

- For facing
- Negative rake.
- 0° end cutting edge angle.

Shank Square	OAL	Insert I.C. T	Model #	Finger Clamp #	Locking Pins #	Shims #	Right Hand Order #	Left Hand Order #	USA Brand	SHARS (D)
1/2"	4"	1/4" 1/8"	MTFN R/L-08-2A	CL-6	M-ZX0410		404-1730	404-1734	\$43.15	<b>\$23.95</b>
5/8	4-1/2	3/8 1/8	MTFN R/L-10-3B*	CL-6	NL-0414	T1603B	404-1731	404-1735	48.10	<b>26.95</b>
3/4	4-1/2	3/8 1/8	MTFN R/L-12-3B*	CL-6	NL-0414	T1603B	404-1732	404-1736	54.75	<b>26.95</b>
1	6	1/2 3/16	MTFN R/L-16-4D	CL-12	NL-0617	T2203B	404-1733	404-1737	58.25	<b>32.95</b>

\*To accept 3/16" thick inserts, order 1/8" thick shims

Insert on page 64

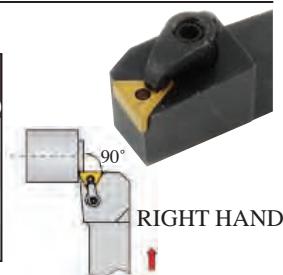

## MTGN Toolholders

- For facing
- Negative rake.
- 0° end cutting edge angle.

Shank Square	OAL	Insert I.C. T	Model #	Finger Clamp #	Locking Pins #	Shims #	Right Hand Order #	Left Hand Order #	USA Brand	SHARS (D)
1/2"	4"	1/4" 1/8"	MTGN R/L-08-2A	CL-6	M-ZX0410		404-1738	404-1742	\$43.15	<b>\$23.95</b>
5/8	4-1/2	3/8 1/8	MTGN R/L-10-3B*	CL-6	NL-0414	T1603B	404-1739	404-1743	48.10	<b>25.95</b>
3/4	4-1/2	3/8 1/8	MTGN R/L-12-3B*	CL-6	NL-0414	T1603B	404-1740	404-1744	54.75	<b>26.95</b>
1	6	1/2 3/16	MTGN R/L-16-4D	CL-12	NL-0617	T2203B	404-1741	404-1745	58.25	<b>32.95</b>

\*To accept 3/16" thick inserts, order 1/8" thick shims

Insert on page 64

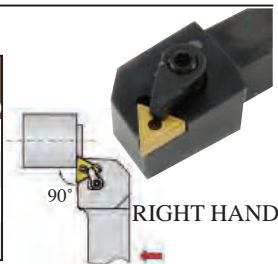

## MTCNN Toolholders

- For facing
- Negative rake.
- 0° end cutting edge angle.

Insert on page 64

Shank WxH	OAL	Insert I.C. T	Model #	Finger Clamp #	Locking Pins #	Shims #	Neutral Order #	USA Brand	SHARS (D)
1/2"x1/2"	4"	3/8" 1/8"	MTCNN -08-3A	CL-6	NL-0410		404-1746	\$43.15	<b>\$23.95</b>
3/4 x 3/4	4-1/2	1/2 3/16	MTCNN -12-4B	CL-12	NL-0617	T2203B	404-1747	55.10	<b>26.95</b>
1/2 x 1	6	3/8 1/8	MTCNN -44-3B	CL-6	NL-0414	T1603B	404-1748	68.86	<b>27.95</b>
3/4 x 1	6	1/2 3/16	MTCNN -64-4D	CL-12	NL-0617	T2203B	404-1749	66.27	<b>29.95</b>
3/4 x 1-1/2	7	1/2 3/16	MTCNN -64-4D	CL-12	NL-0617	T2203B	404-1750	89.68	<b>35.95</b>

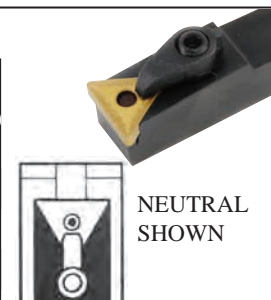

## MTENN Toolholders

- For facing
- Negative rake.
- 30° end cutting edge angle.

Insert on page 64

Shank Square	OAL	Insert I.C. T	Model #	Finger Clamp #	Locking Pins #	Shims #	Neutral Order #	USA Brand	SHARS (D)
1/2"	4"	1/4" 1/8"	MTENN -08-2A	CL-6	M-ZX0410		404-1763	\$43.15	<b>\$23.95</b>
5/8	4-1/2	3/8 1/8	MTENN -10-3B	CL-6	NL-0414	T1603B	404-1764	48.10	<b>25.95</b>
3/4	4-1/2	3/8 1/8	MTENN -12-3B	CL-6	NL-0414	T1603B	404-1765	54.75	<b>29.95</b>
1	6	1/2 3/16	MTENN -16-4D	CL-12	NL-0617	T2203B	404-1766	58.25	<b>32.95</b>

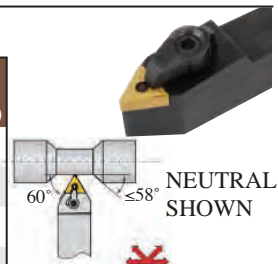

## MTJN Toolholders

- For facing
- Negative rake.
- Negative 3° side cutting edge angle.

Insert on page 64

Shank Square	OAL	Insert I.C. T	Model #	Finger Clamp #	Locking Pins #	Shims #	Right Hand Order #	Left Hand Order #	USA Brand	SHARS (D)
5/8"	4-1/2"	1/4" 1/8"	MTJN R/L-10-2B	CL-6	M-ZX0410		404-1767	404-1769	\$48.10	<b>\$25.95</b>
3/4"	4-1/2"	3/8" 1/8"	MTJN R/L-12-3B	CL-6	NL-0414	T1603B	404-1768	404-1770	54.75	<b>26.95</b>
1	6	3/8 1/8	MTJN R/L-16-3D	CL-6	NL-0414	T1603B	404-1752	404-1758	58.24	<b>30.95</b>
1	6	1/2 3/16	MTJN R/L-16-4D	CL-12	NL-0617	T2203B	404-1753	404-1759	58.24	<b>31.95</b>
1	6	5/8 1/4	MTJN R/L-16-5D	CL-12	NL-0822	T2704B	404-1754	404-1760	58.24	<b>33.95</b>
1-1/4	6	1/2 3/16	MTJN R/L-20-4D	CL-12	NL-0617	T2203B	404-1755	404-1761	63.96	<b>35.95</b>
1-1/4	6	5/8 1/4	MTJN R/L-20-5D	CL-12	NL-0822	T2704B	404-1756	404-1762	63.96	<b>36.95</b>



**CTAP Toolholders**

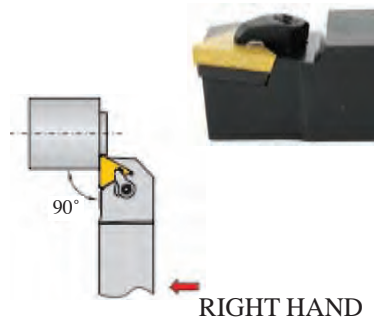

**APPLICATION:**

- For turning or facing to shoulder

**FEATURES:**

- Positive rake. • 0° side cutting edge angle.
- Accept TPG, TPU, & TPMR inserts Page64 • Top clamp

Shank Square	OAL	Insert I.C. T	Model #	Finger Clamp #	Locking Pins #	Shims #	Right Hand Order #	Left Hand Order #	USA Brand	SHARS (D)
3/8"	3-1/2"	1/4" 1/8"	CTAP R/L -06-2J	CL-6	XNS-0517		404-1508	404-1514	\$43.20	<b>\$23.95</b>
1/2	3-1/2	1/4" 1/8"	CTAP R/L -08-2J	CL-6	XNS-0517	TP11D	404-1509	404-1515	43.20	<b>23.95</b>
5/8	4-1/2	1/4 1/8	CTAP R/L -10-2B	CL-6	XNS-0517	TP11D	404-1510	404-1516	48.10	<b>26.95</b>
3/4	4-1/2	3/8 1/8	CTAP R/L -12-3B	CL-6	XNS-0520	TP16D	404-1511	404-1517	54.80	<b>30.95</b>
1	6	3/8 1/8	CTAP R/L -16-3D	CL-6	XNS-0520	TP16D	404-1512	404-1518	58.25	<b>32.95</b>
1	6	1/2 3/16	CTAP R/L -16-4D	CL-12	XNS-0829	TP22D	404-1513	404-1519	58.25	<b>32.95</b>

**CTFP Toolholders**

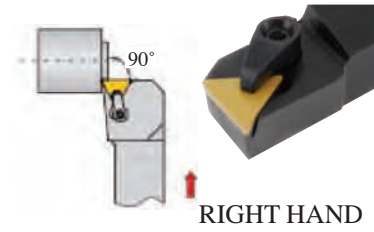

**APPLICATION:**

- For turning or facing

**FEATURES:**

- Positive rake. • 0° side cutting edge angle.
- Accept TPG, TPU, & TPMR inserts Page64 • Top clamp

Shank Square	OAL	Insert I.C. T	Model #	Finger Clamp #	Locking Pins #	Shims #	Right Hand Order #	Left Hand Order #	USA Brand	SHARS (D)
5/8"	4-1/2"	3/8" 1/8"	CTFPR/L-10-3B	CL-6	XNS-0520	TP16D	404-1777	404-1780	\$48.10	<b>\$25.95</b>
3/4	4-1/2	3/8 1/8	CTFPR/L-12-3B	CL-6	XNS-0520	TP16D	404-1778	404-1781	54.75	<b>26.95</b>
1	6	1/2 3/16	CTFPR/L-16-4D	CL-12	XNS-0829	TP22D	404-1779	404-1782	58.25	<b>32.95</b>

**CTGP Toolholders**

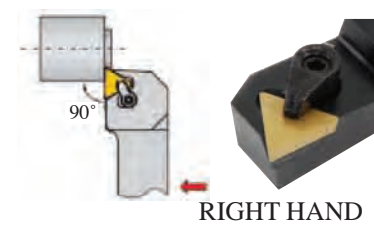

**APPLICATION:**

- For turning or facing

**FEATURES:**

- Positive rake. • 0° side cutting edge angle.
- Accept TPG, TPU, & TPMR inserts Page64 • Top clamp

Shank Square	OAL	Insert I.C. T	Model #	Finger Clamp #	Locking Pins #	Shims #	Right Hand Order #	Left Hand Order #	USA Brand	SHARS (D)
5/8"	4-1/2"	3/8" 1/8"	CTGPR/L-10-3B	CL-6	XNS-0520	TP16D	404-1783	404-1786	\$48.10	<b>\$25.95</b>
3/4	4-1/2	3/8 1/8	CTGPR/L-12-3D	CL-6	XNS-0520	TP16D	404-1784	404-1787	54.75	<b>26.95</b>
1	6	1/2 3/16	CTGPR/L-16-4D	CL-12	XNS-0829	TP22D	404-1785	404-1788	58.25	<b>32.95</b>

**MSDNN Toolholders**

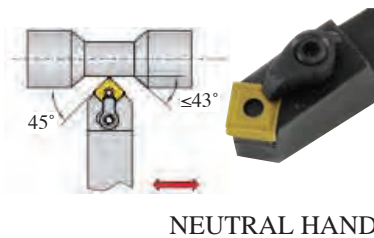

**APPLICATION:**

- For turning, facing or chamfering

**FEATURES:**

- Negative rake. • 45° side cutting edge angle.
- Accept square inserts: SNMZ, SNMA, SNMG, SNMM, SNG, SNU Page63

Shank Square	OAL	Insert I.C. T	Model #	Finger Clamp #	Locking Pins #	Shims #	Neutral Order #	USA Brand	SHARS (D)
1/2"	4"	3/8" 1/8"	MSDNN-08-3A	CL-6	NL-0413	S0903B	404-1789	\$43.15	<b>\$25.95</b>
5/8	4-1/2	3/8 1/8	MSDNN-10-3B	CL-6	NL-0413	S0903B	404-1790	48.10	<b>26.95</b>
3/4	4-1/2	3/8 1/8	MSDNN-12-3B	CL-6	NL-0413	S0903B	404-1791	54.75	<b>27.95</b>
1	6	1/2 3/16	MSDNN-16-4D	CL-12	NL-0617	S1203B	404-1792	58.25	<b>30.95</b>

**MCLN Toolholders**

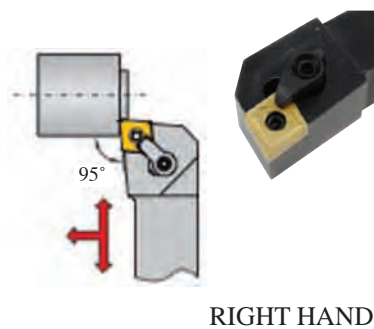

**APPLICATION:**

- For contouring, turning or facing

**FEATURES:**

- Negative rake • Negative 5° side cutting edge angle.
- Accept 80° diamond inserts: CMNA, CNMG, CNMM, CNMP Page61

Shank Square	OAL	Insert I.C. T	Model#	Finger Clamp#	Locking Pins#	Shims#	Right Hand Order#	Left Hand Order#	USA Brand	SHARS (D)
1/2"	4"	3/8" 1/8"	MCLNR/L-08-3A	CL-6	NL-0413	C0903B	404-1775	404-1776	\$52.95	<b>\$26.95</b>
3/4"	4-1/2"	1/2 3/16"	MCLNR/L-12-4B	CL-12	NL-0617	C1203B	404-1793	404-1799	54.75	<b>27.95</b>
1	6	1/2 3/16	MCLNR/L-16-4D	CL-12	NL-0617	C1203B	404-1794	404-1800	58.25	<b>32.95</b>
1	6	5/8 1/4	MCLNR/L-16-5D	CL-12	NL-0822	C1604B	404-1795	404-1801	58.25	<b>32.95</b>
1	6	3/4 1/4	MCLNR/L-16-6D	CL-30	NL-0823	C1904B	404-1796	404-1802	58.25	<b>32.95</b>
1-1/4	6	3/4 1/4	MCLNR/L-20-6D	CL-30	NL-0823	C1904B	404-1797	404-1803	63.96	<b>49.00</b>
1-1/2	7	3/4 1/4	MCLNR/L-24-6E	CL-30	NL-0828	C1904B	404-1798	404-1804	73.20	<b>49.00</b>

**MVJN Toolholders**

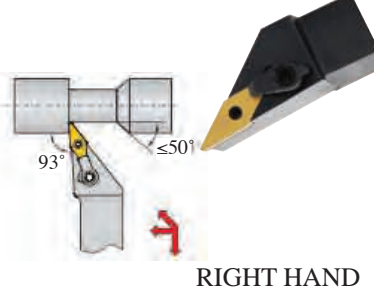

**APPLICATION:**

- For contouring and profiling

**FEATURES:**

- Negative rake • Negative 3° end cutting edge angle
- Accept 35° diamond insert: VNMG, VNMP, VNMZ Page65

Shank Square	OAL	Insert I.C. T	Model#	Finger Clamp#	Locking Pins#	Shims#	Right Hand Order#	Left Hand Order#	USA Brand	SHARS (D)
3/4"	4-1/2"	3/8" 3/16"	MVJNR/L-12-3B	CL-30	NL-0414	V1603B	404-1805	404-1809	\$89.55	<b>\$27.95</b>
3/4	4-1/2	1/2 3/16	MVJNR/L-12-4B	CL-36	NL-0617	V2203B	404-1806	404-1810	89.55	<b>28.95</b>
1	6	3/8 3/16	MVJNR/L-16-3D	CL-30	NL-0414	V1603B	404-1807	404-1811	91.25	<b>30.95</b>
1	6	1/2 3/16	MVJNR/L-16-4D	CL-36	NL-0617	V2203B	404-1808	404-1812	91.25	<b>31.95</b>



## SVVCN Toolholders

- FEATURES:** • 35° POINT. • Style SVVCN has 17-1/2° side Cutting edge angle.
- VCMT2(1.5) 35° • VCMT33 35° **Tin Coated Insert.**

Shank Square	Overall Length	Insert I.C. T	Model #	Order No	USA Brand	SHARS (F)
3/8"	6"	1/4" 3/32"	SVVCN-10	404-1520	\$43.75	<b>\$24.95</b>
1/2"	6"	1/4 3/32	SVVCN-12	404-1521	45.80	<b>26.95</b>
5/8"	6"	3/8" 3/16	SVVCN-16	404-1522	56.70	<b>31.95</b>
3/4"	6"	3/8" 3/16	SVVCN-20	404-1523	62.70	<b>34.95</b>
1"	6"	3/8" 3/16	SVVCN-25	404-1524	66.90	<b>38.95</b>

Insert	Order No	Price
VCMT-2(1.5)	404-1540	<b>\$4.50</b>
VCMT33	404-1562	<b>5.95</b>

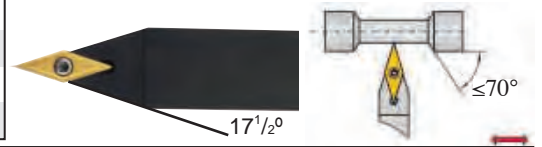

## MWLN R/L Toolholders

- Negative 5° end or side cutting edge angle
- For turning, facing and copying • Accept negative 80° trigon WNM\_ insert Page65

Shank Square	OAL	Insert I.C. T	Model #	Finger Clamp	Clamp Screw	Locking Pins #	Shims #	Right Hand Order #	Left Hand Order #	USA Brand	SHARS (D)
1/2"	4"	3/8" 3/16"	MWLN R/L-08-3A	CL-6	XNS0520	NL0414	W0603B	404-1581	404-1582	\$45.75	<b>\$24.95</b>
3/4"	4-1/2"	3/8" 3/16"	MWLN R/L-12-3B	CL-6	XNS0520	NL0414	W0603B	404-1525	404-1531	54.75	<b>31.95</b>
3/4"	4-1/2"	1/2 3/16	MWLN R/L-12-4B	CL-6	XNS0520	NL0617	W0803B	404-1526	404-1532	54.75	<b>31.95</b>
1"	5"	3/8 3/16	MWLN R/L-16-3C	CL-6	XNS0520	NL0414	W0603B	404-1527	404-1533	58.25	<b>32.95</b>
1"	6"	1/2 3/16	MWLN R/L-16-4D	CL-12	XNS0829	NL0617	W0803B	404-1529	404-1534	58.25	<b>32.95</b>
1-1/4"	6"	1/2 3/16	MWLN R/L-20-4D	CL-12	XNS0829	NL0617	W0803B	404-1530	404-1535	63.95	<b>39.95</b>

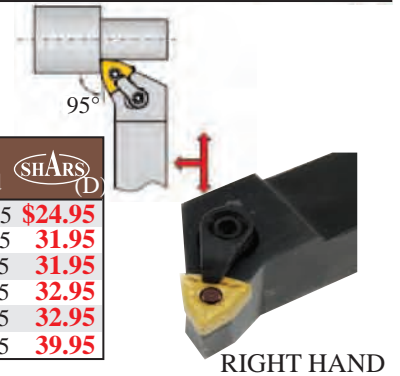

## MDJN R/L Toolholders

- 3° side cutting edge angle
- For turning, facing and copying • Accept negative 55° diamond DNM\_ insert Page62

Shank Square	OAL	Insert I.C. T	Model #	Finger Clamp	Clamp Screw	Locking Pins #	Shims #	Right Hand Order #	Left Hand Order #	USA Brand	SHARS (E)
3/4"	4-1/2"	1/2" 3/16"	MDJN R/L-12-4B	CL-30	XNS0829	NL-0617	D1504B	404-1536	404-1541	\$84.95	<b>\$40.95</b>
1"	6"	1/2 3/16	MDJN R/L-16-4D	CL-30	XNS0829	NL-0617	D1504B	404-1537	404-1542	86.90	<b>44.95</b>
1-1/4"	6"	1/2 3/16	MDJN R/L-20-4D	CL-30	XNS0829	NL-0617	D1504B	404-1538	404-1543	96.20	<b>49.95</b>
1-1/4"	6"	1/2 3/16	MDJN R/L-85-4D	CL-30	XNS0829	NL-0617	D1504B	404-1539	404-1544	86.90	<b>44.95</b>

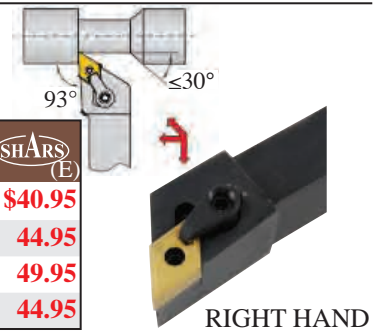

## Small Screw Lock Positive Insert Toolholders

### SCLC R/L Toolholder for CCMT Inserts

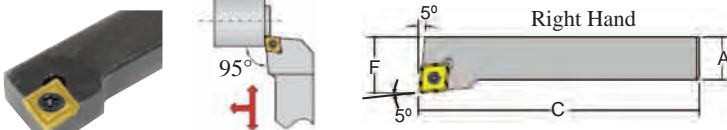

- Negative 5° end or side cutting edge angle for positive 80° diamond CCMT inserts Page61.

A	C	F	CCMT CCGT#	Model #	Right Order #	Left Order #	USA Brand	SHARS (D)
3/8"	3-1/2"	1/2"	21.5	SCLC R/L-06-2J	404-1825	404-1821	\$46.55	<b>\$21.00</b>
1/2"	4"	5/8"	32.5	SCLC R/L-08-3A	404-1826	404-1822	46.55	<b>23.00</b>
5/8"	4-1/2"	3/4"	32.5	SCLC R/L-10-3B	404-1827	404-1823	47.65	<b>25.00</b>
3/4"	4-1/2"	1"	32.5	SCLC R/L-12-3B	404-1828	404-1824	56.65	<b>26.00</b>

### SDJC R/L Toolholder for DCMT Inserts

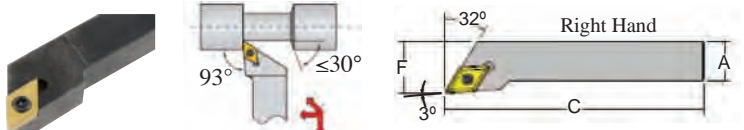

- Negative 3° side cutting edge angle for positive 55° diamond DCMT inserts Page62.

A	C	F	DCMT DCGT#	Model #	Right Order #	Left Order #	USA Brand	SHARS (D)
3/8"	3-1/2"	1/2"	21.5	SDJC R/L-06-2J	404-1833	404-1829	\$56.95	<b>\$22.00</b>
1/2"	4"	5/8"	32.5	SDJC R/L-08-3A	404-1834	404-1830	56.95	<b>24.00</b>
5/8"	4-1/2"	3/4"	32.5	SDJC R/L-10-3B	404-1835	404-1831	48.10	<b>26.00</b>
3/4"	4-1/2"	1"	32.5	SDJC R/L-12-3B	404-1836	404-1832	73.90	<b>27.00</b>

### SVJB R/L Toolholder for VBMT Inserts



- Negative 3° side cutting edge angle for positive 35° diamond VBMT inserts Page64.

A	C	F	VBMT #	Model #	Right Order #	Left Order #	USA Brand	SHARS (D)
1/2"	4"	5/8"	2(1.5)	SVJB R/L-08-2A	404-1874	404-1875	55.95	<b>\$27.95</b>
3/4"	4-1/2"	7/8"	33	SVJB R/L-12-3B	404-1840	404-1837	83.40	<b>32.00</b>
1"	6"	1-1/4"	33	SVJB R/L-16-3D	404-1841	404-1838	84.75	<b>34.00</b>
1-1/4"	6"	1-3/8"	33	SVJB R/L-20-3D	404-1842	404-1839	91.15	<b>36.00</b>

### SSDCN R/L Toolholder for SCMT Inserts



- 45° side cutting edge angle for positive square SCMT inserts Page62.

A	C	F	SCMT Insert #	Model #	USA Brand	SHARS (D)
1/2"	4"	32.5	SSDCN-08-3A	404-1846	\$46.55	<b>\$32.00</b>
5/8"	4-1/2"	32.5	SSDCN-10-3B	404-1847	47.65	<b>34.00</b>
3/4"	4-1/2"	32.5	SSDCN-12-3B	404-1848	56.65	<b>36.00</b>