

Available from: **MARYLAND METRICS** P.O. Box 261 Owings Mills, MD 21117 USA email: sales@mdmetric.com  
 ph: (410)358-3130 (800)638-1830 fx: (410)358-3142 (800)872-9329 web: http://mdmetric.com

Request quotation: <http://mdmetric.com/rfq.htm>

Secure order form: <http://mdmetric.com/secureform.htm>

| Special characteristics  | Operating Pressures   | Materials   |
|--|---|---|
| simple connecting pieces with internal and external threads, nipples:<br>large number of construction versions offering many possible combinations | Straight connector: 75 bar per DIN 10241<br>Elbows and T-pieces: ~10 bar<br><br><b>Temperature range</b><br>-110°C to +300°C. | Type 50 = 1.4571 (AISI 316 Ti)<br>Type 51 = 1.4401 (AISI 316)<br><b>Construction</b><br>Straight connector: made of stainless steel from bar.<br>Elbows and T-pieces: Die casting |
| Note: 1 bar = 14.5 psi   |   |   |

**316 Stainless steel Adaptors - 2005 edition**

G= BSP (BSPP)/(BSPPF) pipe thread (straight) ISO 228

R= BSP (BSPT) pipe thread (tapered) DIN 2999

NPT= NPT pipe thread (tapered) ANSI B 1.20.1

How to order: R950-part number  
example: R950-AD HN 50 -1/4 -1/4

**BSPT Hex nipple**

DIN EN 10241

Series: AD HN 50

| Type - R1 - R2          | SW | L    | e    | kg/100 | \$ each |
|-------------------------|----|------|------|--------|---------|
| R950-AD HN 50 -1/8 -1/8 | 12 | 25,0 | 6,0  | 1,005  | \$4.87  |
| R950-AD HN 50 -1/4 -1/4 | 14 | 31,0 | 8,0  | 1,979  | \$4.92  |
| R950-AD HN 50 -3/8 -3/8 | 17 | 33,0 | 10,5 | 3,180  | \$5.67  |
| R950-AD HN 50 -1/2 -1/2 | 22 | 43,0 | 13,0 | 6,749  | \$6.93  |
| R950-AD HN 50 -3/4 -3/4 | 27 | 48,0 | 21,0 | 7,285  | \$8.95  |
| R950-AD HN 50 -1 -1     | 36 | 52,0 | 26,0 | 13,822 | \$14.54 |

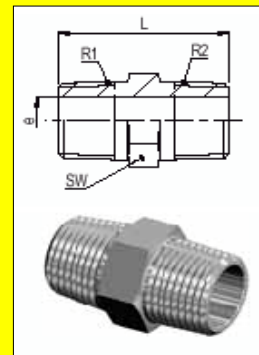

**BSPT/NPT Conversion hex nipple**

DIN EN 10241

Series: AD HN 50 BSP - NPT

| Type - R - NPT             | SW | L    | e    | kg/100 | \$ each |
|----------------------------|----|------|------|--------|---------|
| R950-AD HN 50 -1/8-1/8 NPT | 12 | 25,0 | 6,0  | 1,067  | \$7.23  |
| R950-AD HN 50 -1/4-1/4 NPT | 14 | 31,0 | 8,0  | 2,061  | \$4.79  |
| R950-AD HN 50 -3/8-3/8 NPT | 17 | 33,0 | 10,5 | 3,260  | \$8.32  |
| R950-AD HN 50 -1/2-1/2 NPT | 22 | 43,0 | 13,0 | 6,850  | \$11.72 |
| R950-AD HN 50 -3/4-3/4 NPT | 27 | 48,0 | 21,0 | 7,371  | \$7.90  |
| R950-AD HN 50 -1-1 NPT     | 36 | 52,0 | 26,0 | 13,760 | \$15.55 |

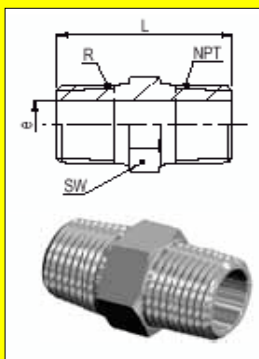

**NPT Hex nipple**

DIN EN 10241

Series: AD HN 50 NPT - NPT

| Type - NPT1 - NPT2              | SW | L    | e    | kg/100 | \$ each |
|---------------------------------|----|------|------|--------|---------|
| R950-AD HN 50 -1/8 NPT -1/8 NPT | 12 | 25,0 | 6,0  | 1,113  | \$10.88 |
| R950-AD HN 50 -1/4 NPT -1/4 NPT | 14 | 31,0 | 8,0  | 2,141  | \$5.63  |
| R950-AD HN 50 -3/8 NPT -3/8 NPT | 17 | 33,0 | 10,5 | 3,340  | \$7.73  |
| R950-AD HN 50 -1/2 NPT -1/2 NPT | 22 | 43,0 | 13,0 | 6,949  | \$9.29  |
| R950-AD HN 50 -3/4 NPT -3/4 NPT | 27 | 48,0 | 21,0 | 7,457  | \$11.18 |
| R950-AD HN 50 -1 NPT -1 NPT     | 36 | 52,0 | 26,0 | 13,698 | \$15.08 |

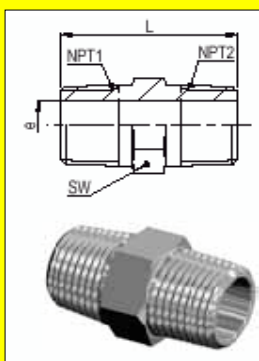

copyright 2004, 2005, 2006 maryland metrics

SW = width across flats

MARYLAND METRICS - Your one-stop METRIC HARDWARE source offers over 1,200,000 METRIC sized items from over 900 suppliers, worldwide: Fasteners, Hand Tools, Cutting Tools, Measuring Tools, Hydraulic & Pneumatic Fittings & Tubing, Oil Seals, O-rings, Bearings, Mechanical Power Transmission Equipment, Workholding Components, Metal Shapes, Plumbing Fittings, Electrical - Lamps, Fuses, Conduit Fittings & Cable. We also offer British sized (whitworth) fasteners & tools.

Available from: **MARYLAND METRICS** P.O. Box 261 Owings Mills, MD 21117 USA  
 ph: (410)358-3130 (800)638-1830 fx: (410)358-3142 (800)872-9329  
 web: <http://mdmetric.com> email: [sales@mdmetric.com](mailto:sales@mdmetric.com)

**Stainless steel Adaptors**  
**BSPT Hex reducing nipple**

Series: AD HRN 50

| Type - R1 - R2           | SW | L    | e    | kg/100 | \$ each |
|--------------------------|----|------|------|--------|---------|
| R950-AD HRN 50 -1/8 -1/4 | 14 | 28,0 | 6,0  | 1,830  | \$5.97  |
| R950-AD HRN 50 -1/8 -3/8 | 17 | 30,0 | 6,0  | 3,193  | \$8.49  |
| R950-AD HRN 50 -1/8 -1/2 | 22 | 35,0 | 6,0  | 6,344  | \$9.87  |
| R950-AD HRN 50 -1/4 -3/8 | 17 | 33,0 | 8,0  | 3,308  | \$6.97  |
| R950-AD HRN 50 -1/4 -1/2 | 22 | 38,0 | 8,0  | 6,385  | \$8.40  |
| R950-AD HRN 50 -3/8 -1/2 | 22 | 38,0 | 10,5 | 6,128  | \$8.49  |
| R950-AD HRN 50 -1/2 -3/4 | 27 | 46,5 | 13,0 | 11,548 | \$12.69 |
| R950-AD HRN 50 -1/2 -1   | 36 | 48,5 | 13,0 | 20,172 | \$16.39 |
| R950-AD HRN 50 -3/4 -1   | 36 | 50,0 | 21,0 | 15,600 | \$16.81 |

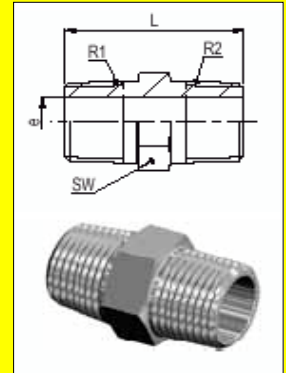

G= BSP (BSPP)/(BSPF) pipe thread (straight) ISO 228  
 R= BSP (BSPT) pipe thread (tapered) DIN 2999  
 NPT= NPT pipe thread (tapered) ANSI B 1.20.1

SW = width across flats

**BSPP/BSPT Adapter**

Series: AD A 50

| Type - G - R           | SW | L    | L1   | L2   | e    | kg/100 | \$ each |
|------------------------|----|------|------|------|------|--------|---------|
| R950-AD A 50 -1/8 -1/8 | 14 | 21,0 | 9,5  | 8,0  | 6,0  | 1,226  | \$6.76  |
| R950-AD A 50 -1/4 -1/4 | 17 | 26,0 | 12,5 | 9,0  | 8,0  | 2,192  | \$9.92  |
| R950-AD A 50 -3/8 -3/8 | 22 | 27,0 | 12,5 | 9,5  | 10,5 | 3,698  | \$10.80 |
| R950-AD A 50 -1/2 -1/2 | 27 | 35,0 | 17,5 | 11,5 | 13,0 | 7,183  | \$12.73 |
| R950-AD A 50 -3/4 -3/4 | 32 | 40,0 | 19,0 | 14,0 | 21,0 | 9,166  | \$15.34 |
| R950-AD A 50 -1 -1     | 41 | 45,0 | 21,0 | 17,0 | 26,0 | 17,524 | \$19.83 |

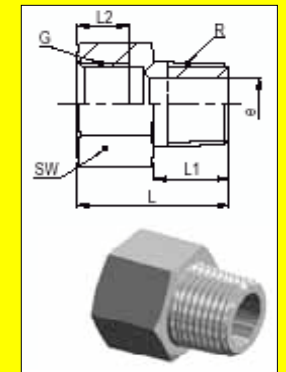

**BSPP/NPT Conversion Adapter**

Series: AD A 50 NPT - BSP

| Type - G - NPT             | SW | L    | L1   | L2   | e    | kg/100 | \$ each |
|----------------------------|----|------|------|------|------|--------|---------|
| R950-AD A 50 -1/8 -1/8 NPT | 14 | 21,0 | 9,5  | 8,0  | 6,0  | 1,277  | \$9.66  |
| R950-AD A 50 -1/4 -1/4 NPT | 17 | 26,0 | 12,5 | 9,0  | 8,0  | 2,271  | \$7.10  |
| R950-AD A 50 -3/8 -3/8 NPT | 22 | 27,0 | 12,5 | 9,5  | 10,5 | 3,786  | \$8.66  |
| R950-AD A 50 -1/2 -1/2 NPT | 27 | 35,0 | 17,5 | 11,5 | 13,0 | 7,280  | \$13.66 |
| R950-AD A 50 -3/4 -3/4 NPT | 32 | 40,0 | 19,0 | 14,0 | 21,0 | 9,252  | \$15.67 |
| R950-AD A 50 -1 -1 NPT     | 41 | 45,0 | 21,0 | 17,0 | 26,0 | 17,482 | \$20.25 |

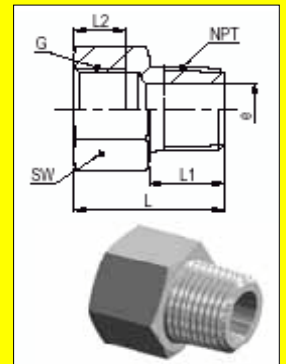

**NPT/BSPT Conversion Adapter**

Series: AD A 50 NPT

| Type - NPT - R             | SW | L    | L1   | L2   | e    | kg/100 | \$ each |
|----------------------------|----|------|------|------|------|--------|---------|
| R950-AD A 50 -1/8 NPT -1/8 | 14 | 21,0 | 9,5  | 10,0 | 6,0  | 1,239  | \$12.35 |
| R950-AD A 50 -1/4 NPT -1/4 | 17 | 29,0 | 12,5 | 14,0 | 8,0  | 2,424  | \$10.17 |
| R950-AD A 50 -3/8 NPT -3/8 | 22 | 29,0 | 12,5 | 14,0 | 10,5 | 3,800  | \$12.39 |
| R950-AD A 50 -1/2 NPT -1/2 | 27 | 38,0 | 17,5 | 18,0 | 13,0 | 8,108  | \$11.60 |
| R950-AD A 50 -3/4 NPT -3/4 | 32 | 43,0 | 19,0 | 20,0 | 21,0 | 10,371 | \$14.58 |
| R950-AD A 50 -1 NPT -1     | 36 | 45,0 | 21,0 | 23,0 | 26,0 | 12,020 | \$19.50 |

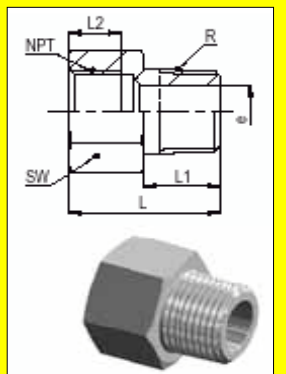

Available from: **MARYLAND METRICS** P.O. Box 261 Owings Mills, MD 21117 USA  
 ph: (410)358-3130 (800)638-1830 fx: (410)358-3142 (800)872-9329  
 web: <http://mdmetric.com> email: [sales@mdmetric.com](mailto:sales@mdmetric.com)

**Stainless steel Adaptors**

**BSPP/BSPT Reducing Adapter**

Series: AD RA 50

| Type - G - R           | SW | L    | L1   | L2   | e    | kg/100 | \$ each |
|------------------------|----|------|------|------|------|--------|---------|
| R950-AD RA 50 -1/4-1/8 | 17 | 23,0 | 9,5  | 9,0  | 6,0  | 1,776  | \$5.71  |
| R950-AD RA 50 -3/8-1/4 | 22 | 28,0 | 12,5 | 9,5  | 8,0  | 3,586  | \$8.32  |
| R950-AD RA 50 -1/2-1/4 | 27 | 31,0 | 12,5 | 11,0 | 8,0  | 5,815  | \$10.13 |
| R950-AD RA 50 -1/2-3/8 | 27 | 30,0 | 12,5 | 11,5 | 10,5 | 5,780  | \$9.71  |
| R950-AD RA 50 -3/4-1/2 | 32 | 39,0 | 17,5 | 14,0 | 13,0 | 9,662  | \$12.35 |
| R950-AD RA 50 -1-1/2   | 41 | 45,0 | 17,5 | 17,0 | 13,0 | 18,781 | \$20.00 |
| R950-AD RA 50 -1-3/4   | 41 | 45,0 | 19,0 | 17,0 | 21,0 | 17,126 | \$19.75 |

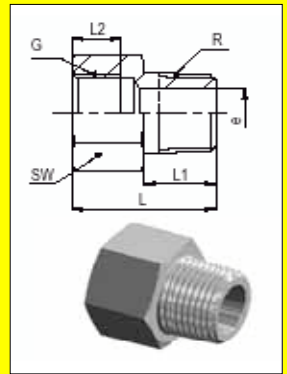

**BSPP/NPT Conversion reducing adapter**

Series: AD RA 50 BSP – NPT

| Type - G - NPT             | SW | L    | L1   | e    | kg/100 | \$ each |
|----------------------------|----|------|------|------|--------|---------|
| R950-AD RA 50 -1/4-1/8 NPT | 17 | 23,0 | 9,5  | 6,0  | 1,827  | \$7.02  |
| R950-AD RA 50 -3/8-1/4 NPT | 22 | 28,0 | 12,5 | 8,0  | 3,666  | \$8.95  |
| R950-AD RA 50 -1/2-1/4 NPT | 27 | 31,0 | 12,5 | 8,0  | 5,895  | \$11.13 |
| R950-AD RA 50 -1/2-3/8 NPT | 27 | 30,0 | 12,5 | 10,5 | 5,868  | \$10.71 |
| R950-AD RA 50 -3/4-1/2 NPT | 32 | 39,0 | 17,5 | 13,0 | 9,759  | \$13.28 |
| R950-AD RA 50 -1-3/4 NPT   | 41 | 45,0 | 19,0 | 21,0 | 17,213 | \$20.25 |

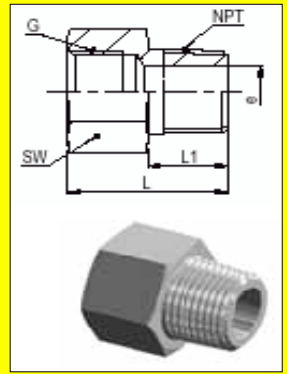

G= BSP (BSPP)/(BSPF) pipe thread (straight) ISO 228

R= BSP (BSPT) pipe thread (tapered) DIN 2999

NPT= NPT pipe thread (tapered) ANSI B 1.20.1

**NPT/NPT Reducing Adapter**

Series: AD RA 50 NPT – NPT

| Type -NPT -NPT                  | SW | L  | L1   | L2   | e    | kg/100 | \$ each |
|---------------------------------|----|----|------|------|------|--------|---------|
| R950-AD RA 50 -1/4 NPT -1/8 NPT | 17 | 26 | 9,5  | 10,2 | 6    | 2,150  | \$6.29  |
| R950-AD RA 50 -3/8 NPT -1/4 NPT | 22 | 30 | 12,5 | 10,3 | 8    | 3,920  | \$9.15  |
| R950-AD RA 50 -1/2 NPT -1/4 NPT | 27 | 35 | 12,5 | 13,5 | 8    | 7,505  | \$11.14 |
| R950-AD RA 50 -1/2 NPT -3/8 NPT | 27 | 35 | 12,5 | 13,5 | 10,5 | 7,866  | \$10.68 |
| R950-AD RA 50 -3/4 NPT -1/2 NPT | 32 | 43 | 17,5 | 13,8 | 13   | 12,030 | \$13.59 |
| R950-AD RA 50 -1 NPT -1/2 NPT   | 36 | 48 | 17,5 | 17,4 | 13   | 14,540 | \$22.00 |
| R950-AD RA 50 -1 NPT -3/4 NPT   | 36 | 48 | 19   | 17,4 | 21   | 13,110 | \$21.72 |

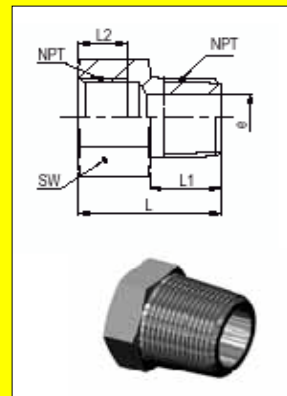

**BSPP/BSPT Hex bushing**

Series: AD RB 50

| Type - G - R           | SW | L    | L1   | L2   | e    | kg/100 | \$ each |
|------------------------|----|------|------|------|------|--------|---------|
| R950-AD RB 50-1/8 -1/4 | 14 | 18,5 | 12,5 | 8,0  | 8,6  | 1,139  | \$4.41  |
| R950-AD RB 50-1/8 -3/8 | 17 | 20,5 | 12,5 | 8,0  | 8,6  | 2,456  | \$6.64  |
| R950-AD RB 50-1/8 -1/2 | 22 | 25,5 | 17,5 | 8,0  | 8,6  | 5,502  | \$7.48  |
| R950-AD RB 50-1/4 -3/8 | 17 | 20,5 | 12,5 | 9,0  | 11,4 | 1,798  | \$5.17  |
| R950-AD RB 50-1/4 -1/2 | 22 | 25,5 | 17,5 | 9,0  | 11,4 | 4,693  | \$6.09  |
| R950-AD RB 50-1/4 -3/4 | 27 | 29,0 | 19,0 | 9,0  | 11,4 | 9,574  | \$9.41  |
| R950-AD RB 50-3/8 -1/2 | 22 | 25,5 | 17,5 | 9,5  | 15,0 | 3,939  | \$6.34  |
| R950-AD RB 50-3/8 -3/4 | 27 | 29,0 | 19,0 | 9,5  | 15,0 | 7,647  | \$9.37  |
| R950-AD RB 50-3/8 -1   | 36 | 31,0 | 21,0 | 9,5  | 15,0 | 16,634 | \$14.12 |
| R950-AD RB 50-1/2 -3/4 | 27 | 29,0 | 19,0 | 11,5 | 18,6 | 6,079  | \$8.70  |
| R950-AD RB 50-1/2 -1   | 36 | 31,0 | 21,0 | 11,5 | 18,6 | 14,496 | \$11.85 |
| R950-AD RB 50-3/4 -1   | 36 | 31,0 | 21,0 | 14,0 | 24,1 | 10,487 | \$11.97 |

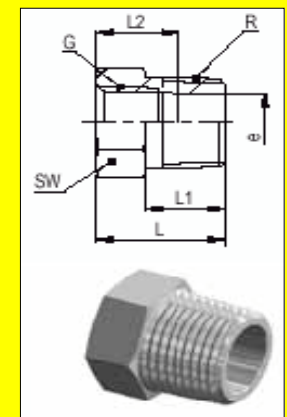

Available from: **MARYLAND METRICS** P.O. Box 261 Owings Mills, MD 21117 USA  
 ph: (410)358-3130 (800)638-1830 fx: (410)358-3142 (800)872-9329  
 web: <http://mdmetric.com> email: [sales@mdmetric.com](mailto:sales@mdmetric.com)

**Stainless steel Adaptors**

**BSPP/NPT Conversion hex bushing**

DIN EN 10241

Series: AD RB 50 BSP – NPT

| Type - G - NPT             | SW | L    | L1   | L2   | e    | kg/100 | \$ each |
|----------------------------|----|------|------|------|------|--------|---------|
| R950-AD RB 50-1/8 -1/4 NPT | 14 | 18,5 | 12,5 | 8,0  | 8,6  | 1,220  | \$6.72  |
| R950-AD RB 50-1/8 -3/8 NPT | 17 | 20,5 | 12,5 | 8,0  | 8,6  | 2,537  | \$9.92  |
| R950-AD RB 50-1/8 -1/2 NPT | 22 | 25,5 | 17,5 | 8,0  | 8,6  | 5,600  | \$8.19  |
| R950-AD RB 50-1/4 -3/8 NPT | 17 | 20,5 | 12,5 | 9,0  | 11,4 | 1,879  | \$7.44  |
| R950-AD RB 50-1/4 -1/2 NPT | 22 | 25,5 | 17,5 | 9,0  | 11,4 | 4,791  | \$8.40  |
| R950-AD RB 50-1/4 -3/4 NPT | 27 | 29,0 | 19,0 | 9,0  | 11,4 | 9,660  | \$10.08 |
| R950-AD RB 50-3/8 -1/2 NPT | 22 | 25,5 | 17,5 | 9,5  | 15,0 | 3,490  | \$10.84 |
| R950-AD RB 50-1/2 -3/4 NPT | 27 | 29,0 | 19,0 | 11,5 | 18,6 | 6,165  | \$10.25 |
| R950-AD RB 50-3/4 -1 NPT   | 36 | 31,0 | 21,0 | 14,0 | 24,1 | 10,445 | \$15.17 |

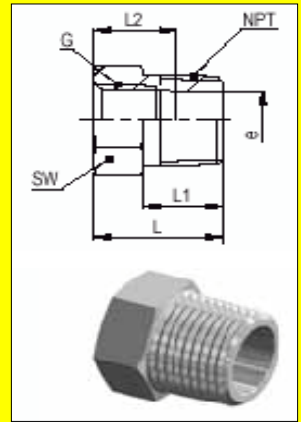

G= BSP (BSPP)/(BSPF) pipe thread (straight) ISO 228

R= BSP (BSPT) pipe thread (tapered) DIN 2999

NPT= NPT pipe thread (tapered) ANSI B 1.20.1

**NPT Conversion hex bushing**

DIN EN 10241

Series: AD RB 50 NPT – BSP

| Type - NPT - R             | SW | L    | L1   | L2   | e    | kg/100 | \$ each |
|----------------------------|----|------|------|------|------|--------|---------|
| R950-AD RB 50-1/8 NPT -1/4 | 14 | 18,5 | 12,5 | 6,7  | 8,4  | 1,142  | \$7.77  |
| R950-AD RB 50-1/4 NPT -3/8 | 17 | 20,5 | 12,5 | 10,2 | 10,8 | 1,869  | \$10.55 |
| R950-AD RB 50-1/4 NPT -1/2 | 22 | 25,5 | 17,5 | 10,2 | 10,8 | 4,802  | \$11.93 |
| R950-AD RB 50-1/2 NPT -3/4 | 27 | 29,0 | 19,0 | 13,5 | 17,7 | 6,418  | \$14.08 |

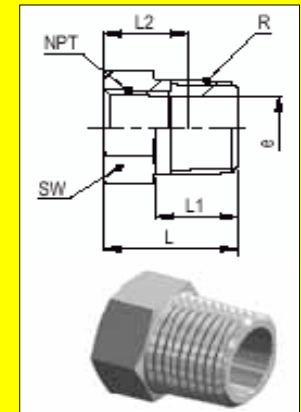

**NPT Hex bushing**

Series: AD RB 50 NPT - NPT

| Type NPT - NPT                 | SW | L    | L1   | L2   | e    | kg/100 | \$ each |
|--------------------------------|----|------|------|------|------|--------|---------|
| R950-AD RB 50-1/8 NPT -1/4 NPT | 14 | 18,5 | 12,5 | 6,7  | 8,4  | 1,280  | \$4.85  |
| R950-AD RB 50-1/8 NPT -3/8 NPT | 17 | 20,5 | 12,5 | 6,7  | 8,4  | 2,660  | \$7.30  |
| R950-AD RB 50-1/4 NPT -3/8 NPT | 17 | 20,5 | 12,5 | 10,2 | 10,8 | 2,070  | \$5.68  |
| R950-AD RB 50-1/4 NPT -1/2 NPT | 22 | 25,5 | 17,5 | 10,2 | 10,8 | 5,150  | \$6.70  |
| R950-AD RB 50-3/8 NPT -1/2 NPT | 22 | 25,5 | 17,5 | 10,3 | 13,9 | 3,980  | \$6.98  |
| R950-AD RB 50-1/2 NPT -3/4 NPT | 27 | 29   | 19   | 13,5 | 17,7 | 6,820  | \$9.57  |
| R950-AD RB 50-1/2 NPT -1 NPT   | 36 | 31   | 21   | 13,5 | 17,7 | 15,510 | \$13.03 |
| R950-AD RB 50-3/4 NPT -1 NPT   | 36 | 31   | 21   | 13,8 | 22,5 | 11,920 | \$13.17 |

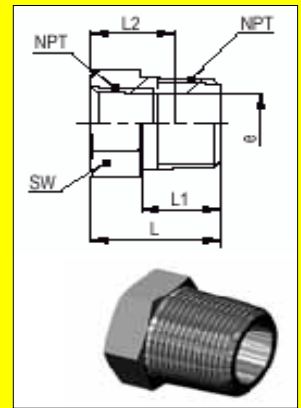

**BSPP Hex coupling**

DIN EN 10241

Series: AD HC 50

| Type - G               | SW | L    | e    | kg/100 | \$ each |
|------------------------|----|------|------|--------|---------|
| R950-AD HC 50 -1/8-1/8 | 17 | 17,0 | 8,6  | 2,278  | \$6.43  |
| R950-AD HC 50 -1/4-1/4 | 22 | 25,0 | 11,4 | 5,500  | \$7.18  |
| R950-AD HC 50 -3/8-3/8 | 22 | 26,0 | 15,0 | 4,391  | \$8.82  |
| R950-AD HC 50 -1/2-1/2 | 27 | 34,0 | 18,6 | 8,425  | \$8.28  |
| R950-AD HC 50 -3/4-3/4 | 32 | 36,0 | 24,1 | 10,686 | \$12.77 |
| R950-AD HC 50 -1-1     | 46 | 43,0 | 30,3 | 33,192 | \$20.08 |

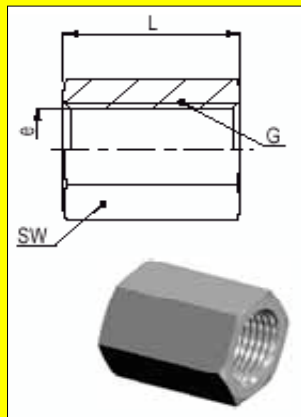

Available from: **MARYLAND METRICS** P.O. Box 261 Owings Mills, MD 21117 USA

ph: (410)358-3130 (800)638-1830 fx: (410)358-3142 (800)872-9329

web: <http://mdmetric.com> email: [sales@mdmetric.com](mailto:sales@mdmetric.com)

**Stainless steel Adaptors**

**BSPP Hex reducing coupling**

DIN EN 10241

Series: AD HRC 50

| Type - G1- G2           | SW | L    | L1   | L2   | e    | kg/100 | \$ each |
|-------------------------|----|------|------|------|------|--------|---------|
| R950-AD HRC 50-1/8 -1/4 | 22 | 25,0 | 8,0  | 9,0  | 8,6  | 5,938  | \$10.25 |
| R950-AD HRC 50-1/8 -3/8 | 22 | 30,0 | 8,0  | 9,5  | 8,6  | 6,500  | \$11.09 |
| R950-AD HRC 50-1/8 -1/2 | 27 | 41,0 | 8,0  | 11,5 | 8,6  | 14,097 | \$13.28 |
| R950-AD HRC 50-1/4 -3/8 | 22 | 29,0 | 9,0  | 9,5  | 11,4 | 5,746  | \$10.67 |
| R950-AD HRC 50-1/4 -1/2 | 27 | 40,0 | 9,0  | 11,5 | 11,4 | 12,941 | \$12.86 |
| R950-AD HRC 50-3/8 -1/2 | 27 | 38,0 | 9,5  | 11,5 | 15,0 | 11,055 | \$12.48 |
| R950-AD HRC 50-1/2 -3/4 | 32 | 41,0 | 11,5 | 14,0 | 18,6 | 15,200 | \$15.04 |
| R950-AD HRC 50-1/2 -1   | 46 | 51,0 | 11,5 | 17,0 | 18,6 | 48,706 | \$23.02 |

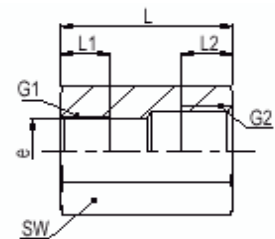

G= BSP (BSPP)/(BSPF) pipe thread (straight) ISO 228

R= BSP (BSPT) pipe thread (tapered) DIN 2999

NPT= NPT pipe thread (tapered) ANSI B 1.20.1

**BSPP Female elbow**

Series: AD FE 51

| Type - G               |  |  |  | H    | kg/100 | \$ each |
|------------------------|--|--|--|------|--------|---------|
| R950-AD FE 51-1/8 -1/8 |  |  |  | 20,0 | 3,700  | \$3.24  |
| R950-AD FE 51-1/4 -1/4 |  |  |  | 21,0 | 5,100  | \$3.11  |
| R950-AD FE 51-3/8 -3/8 |  |  |  | 25,0 | 6,600  | \$3.82  |
| R950-AD FE 51-1/2 -1/2 |  |  |  | 28,0 | 9,000  | \$4.33  |
| R950-AD FE 51-3/4 -3/4 |  |  |  | 33,0 | 19,100 | \$5.25  |
| R950-AD FE 51-1 -1     |  |  |  | 38,0 | 27,800 | \$8.70  |

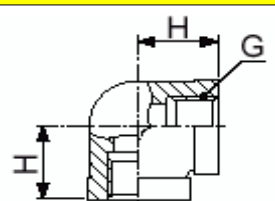

**BSPP/BSPT Street elbow**

Series: AD SE 51

| Type - G - R            |  |  |  | H    | H1   | kg/100 | \$ each |
|-------------------------|--|--|--|------|------|--------|---------|
| R950-AD SE 51 -1/8 -1/8 |  |  |  | 20,0 | 26,0 | 2,800  | \$3.07  |
| R950-AD SE 51 -1/4 -1/4 |  |  |  | 21,0 | 30,0 | 3,600  | \$3.82  |
| R950-AD SE 51 -3/8 -3/8 |  |  |  | 25,0 | 36,0 | 6,500  | \$4.33  |
| R950-AD SE 51 -1/2 -1/2 |  |  |  | 28,0 | 41,0 | 11,200 | \$5.08  |
| R950-AD SE 51 -3/4 -3/4 |  |  |  | 33,0 | 48,0 | 16,100 | \$7.73  |
| R950-AD SE 51 -1 -1     |  |  |  | 38,0 | 54,0 | 25,600 | \$12.52 |

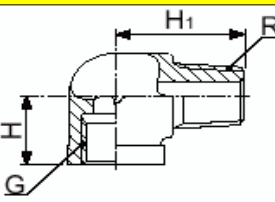

**BSPP Female Tee AD FT 51**

Series: AD FT 51

| Type - G               |  |  |  | H    | L    | kg/100 | \$ each |
|------------------------|--|--|--|------|------|--------|---------|
| R950-AD FT 51 -1/8-1/8 |  |  |  | 20,0 | 40,0 | 3,000  | \$4.24  |
| R950-AD FT 51 -1/4-1/4 |  |  |  | 21,0 | 42,0 | 7,300  | \$4.96  |
| R950-AD FT 51 -3/8-3/8 |  |  |  | 25,0 | 50,0 | 10,100 | \$4.29  |
| R950-AD FT 51 -1/2-1/2 |  |  |  | 28,0 | 56,0 | 16,400 | \$5.50  |
| R950-AD FT 51 -3/4-3/4 |  |  |  | 32,0 | 64,0 | 22,500 | \$7.81  |
| R950-AD FT 51 -1-1     |  |  |  | 38,0 | 76,0 | 37,000 | \$12.73 |

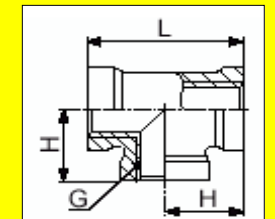

Available from: **MARYLAND METRICS** P.O. Box 261 Owings Mills, MD 21117 USA  
 ph: (410)358-3130 (800)638-1830 fx: (410)358-3142 (800)872-9329  
 web: <http://mdmetric.com> email: [sales@mdmetric.com](mailto:sales@mdmetric.com)

**Stainless steel Adaptors**

**BSPP Hex Cap**

DIN EN 10241

Series: AD HCP 50

| Type – G            |  |  | SW | L    | L1   | kg/100 | \$ each |
|---------------------|--|--|----|------|------|--------|---------|
| R950-AD HCP 50 –1/8 |  |  | 17 | 19,0 | 8,0  | 2,757  | \$4.92  |
| R950-AD HCP 50 –1/4 |  |  | 22 | 24,0 | 9,0  | 5,932  | \$4.50  |
| R950-AD HCP 50 –3/8 |  |  | 22 | 27,0 | 9,5  | 5,875  | \$5.97  |
| R950-AD HCP 50 –1/2 |  |  | 27 | 37,0 | 11,5 | 12,700 | \$7.39  |
| R950-AD HCP 50 –3/4 |  |  | 32 | 38,0 | 14,0 | 16,363 | \$8.87  |
| R950-AD HCP 50 –1   |  |  | 46 | 44,0 | 17,0 | 43,193 | \$14.87 |

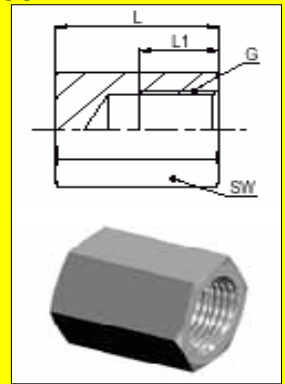

G= BSP (BSPP)/(BSPF) pipe thread (straight) ISO 228

R= BSP (BSPT) pipe thread (tapered) DIN 2999

NPT= NPT pipe thread (tapered) ANSI B 1.20.1

**BSPT Hex Plug**

DIN EN

Series: AD HP 50

| Type – R           |  |  | SW | L    | L1   | kg/100 | \$ each |
|--------------------|--|--|----|------|------|--------|---------|
| R950-AD HP 50 –1/8 |  |  | 12 | 15,5 | 9,5  | 1,017  | \$2.90  |
| R950-AD HP 50 –1/4 |  |  | 14 | 18,5 | 12,5 | 1,892  | \$2.90  |
| R950-AD HP 50 –3/8 |  |  | 17 | 20,5 | 12,5 | 3,289  | \$3.66  |
| R950-AD HP 50 –1/2 |  |  | 22 | 25,5 | 17,5 | 6,548  | \$4.45  |
| R950-AD HP 50 –3/4 |  |  | 27 | 29,0 | 19,0 | 11,671 | \$6.60  |
| R950-AD HP 50 –1   |  |  | 36 | 31,0 | 21,0 | 20,534 | \$8.91  |

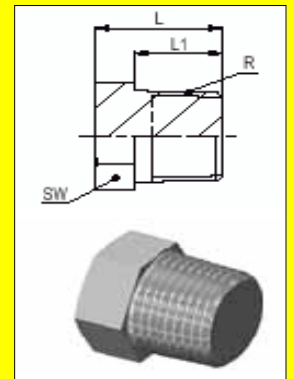

**NPT Hex Plug**

DIN EN 10241

Series: AD HP 50 NPT

| Type – NPT             |  |  | SW | L    | L1   | kg/100 | \$ each |
|------------------------|--|--|----|------|------|--------|---------|
| R950-AD HP 50 –1/8 NPT |  |  | 12 | 15,5 | 9,5  | 1,070  | \$2.86  |
| R950-AD HP 50 –1/4 NPT |  |  | 14 | 18,5 | 12,5 | 1,973  | \$2.73  |
| R950-AD HP 50 –3/8 NPT |  |  | 17 | 20,5 | 12,5 | 3,370  | \$4.83  |
| R950-AD HP 50 –1/2 NPT |  |  | 22 | 25,5 | 17,5 | 6,647  | \$3.91  |
| R950-AD HP 50 –3/4 NPT |  |  | 27 | 29,0 | 19,0 | 11,756 | \$5.25  |
| R950-AD HP 50 –1 NPT   |  |  | 36 | 31,0 | 21,0 | 20,472 | \$9.03  |

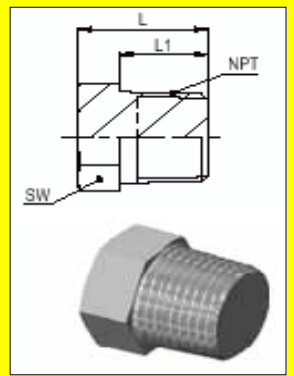

**BSPT Socket Screw Plug**

Series: AD SP 50

| Type R             |  |  | R   | SW | B  | kg/100 | \$ each |
|--------------------|--|--|-----|----|----|--------|---------|
| R950-AD SP 50 –1/8 |  |  | 1/8 | 5  | 8  | 0,340  | \$2.08  |
| R950-AD SP 50 –1/4 |  |  | 1/4 | 7  | 10 | 0,700  | \$3.47  |
| R950-AD SP 50 –3/8 |  |  | 3/8 | 8  | 10 | 1,200  | \$4.81  |
| R950-AD SP 50 –1/2 |  |  | 1/2 | 10 | 10 | 1,940  | \$6.47  |
| R950-AD SP 50 –3/4 |  |  | 3/4 | 12 | 12 | 3,800  | \$14.00 |
| R950-AD HP 50 –1   |  |  | 1   | 17 | 12 | 5,760  | \$19.29 |

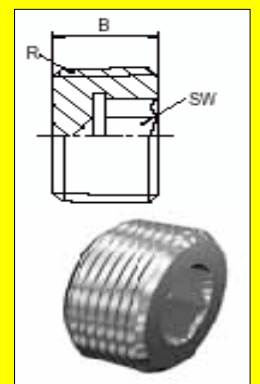

Available from: **MARYLAND METRICS** P.O. Box 261 Owings Mills, MD 21117 USA  
 ph: (410)358-3130 (800)638-1830 fx: (410)358-3142 (800)872-9329  
 web: <http://mdmetric.com> email: [sales@mdmetric.com](mailto:sales@mdmetric.com)

**Stainless steel Adaptors**

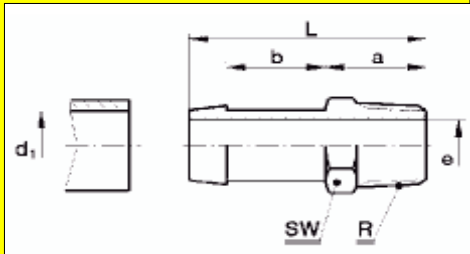

**BSPT Male adaptor hose nozzle**

Series: SO 50511

| Type – d1– R          | SW | L    | b  | a    | e  | kg/100 | \$ each |
|-----------------------|----|------|----|------|----|--------|---------|
| R950-SO 50511-4 -1/8  | 10 | 23   | 8  | 12   | 3  | 0,700  | \$15.26 |
| R950-SO 50511-4 -1/4  | 14 | 28,5 | 8  | 17,5 | 3  | 1,540  | \$15.83 |
| R950-SO 50511-6 -1/8  | 10 | 29   | 12 | 12   | 4  | 0,910  | \$13.11 |
| R950-SO 50511-6 -1/4  | 14 | 34,5 | 12 | 17,5 | 4  | 1,710  | \$14.04 |
| R950-SO 50511-6 -1/2  | 22 | 40   | 12 | 23   | 4  | 4,130  | \$23.64 |
| R950-SO 50511-8 -1/8  | 10 | 29   | 12 | 12   | 6  | 9,710  | \$14.18 |
| R950-SO 50511-8 -1/4  | 14 | 34,5 | 12 | 17,5 | 6  | 1,740  | \$15.19 |
| R950-SO 50511-8 -1/2  | 22 | 40   | 12 | 23   | 6  | 4,220  | \$27.22 |
| R950-SO 50511-10 -1/4 | 14 | 36,5 | 14 | 17,5 | 7  | 1,540  | \$16.76 |
| R950-SO 50511-10 -3/8 | 17 | 37   | 14 | 18   | 7  | 3,030  | \$18.34 |
| R950-SO 50511-10 -1/2 | 22 | 42   | 14 | 23   | 7  | 4,470  | \$31.38 |
| R950-SO 50511-13 -3/8 | 17 | 39   | 15 | 18   | 10 | 3,730  | \$22.78 |
| R950-SO 50511-13 -1/2 | 22 | 44   | 15 | 23   | 10 | 5,320  | \$32.67 |
| R950-SO 50511-16 -1/2 | 22 | 49   | 18 | 23   | 13 | 5,930  | \$33.67 |
| R950-SO 50511-19 -1/2 | 22 | 49   | 18 | 23   | 16 | 7,340  | \$37.18 |
| R950-SO 50511-19 -3/4 | 27 | 51   | 18 | 25   | 16 | 10,550 | \$45.42 |
| R950-SO 50511-25 -1   | 36 | 59   | 19 | 30   | 22 | 17,160 | \$64.33 |

R = BSP Pipe thread (tapered)

d1= corresponds to the inside diameter of the hose

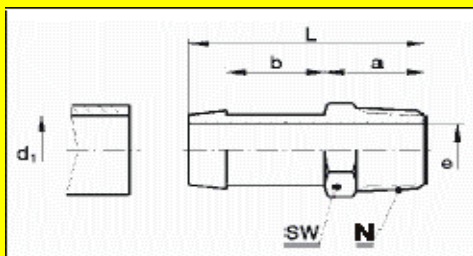

**NPT Male adaptor hose nozzle**

Series: SO 50511 NPT

| Type – d1– R              | SW | L    | b  | a    | e   | kg/100 | \$ each |
|---------------------------|----|------|----|------|-----|--------|---------|
| R950-SO 50511-4 -1/8 NPT  | 12 | 25,5 | 8  | 14,5 | 3   | 1,000  | \$16.33 |
| R950-SO 50511-4 -1/4 NPT  | 14 | 30,5 | 8  | 19,5 | 3   | 1,990  | \$16.94 |
| R950-SO 50511-6 -1/8 NPT  | 12 | 31,5 | 12 | 14,5 | 4   | 1,200  | \$14.07 |
| R950-SO 50511-6 -1/4 NPT  | 14 | 36,5 | 12 | 19,5 | 4   | 2,190  | \$15.02 |
| R950-SO 50511-8 -1/8 NPT  | 12 | 31,5 | 12 | 14,5 | 6   | 1,170  | \$15.18 |
| R950-SO 50511-8 -1/4 NPT  | 14 | 36,5 | 12 | 19,5 | 6,5 | 2,180  | \$16.25 |
| R950-SO 50511-10 -1/4 NPT | 14 | 38,5 | 14 | 19,5 | 7   | 2,500  | \$17.93 |
| R950-SO 50511-10 -3/8 NPT | 17 | 39   | 14 | 20   | 7   | 2,700  | \$19.62 |
| R950-SO 50511-10 -1/2 NPT | 22 | 45   | 14 | 26   | 7   | 5,530  | \$33.57 |
| R950-SO 50511-13 -3/8 NPT | 17 | 41   | 15 | 20   | 10  | 3,600  | \$24.38 |
| R950-SO 50511-13 -1/2 NPT | 22 | 47   | 15 | 26   | 10  | 5,830  | \$34.95 |
| R950-SO 50511-16 -1/2 NPT | 22 | 52   | 18 | 26   | 13  | 6,620  | \$36.02 |
| R950-SO 50511-19 -1/2 NPT | 22 | 52   | 18 | 26   | 14  | 6,460  | \$39.79 |
| R950-SO 50511-19 -3/4 NPT | 30 | 55   | 18 | 29   | 16  | 10,330 | \$48.59 |
| R950-SO 50511-25 -3/4 NPT | 30 | 59   | 20 | 29   | 19  | 9,850  | \$68.83 |
| R950-SO 50511-25 -1 NPT   | 36 | 63   | 20 | 33   | 22  | 16,500 | \$68.83 |

N = NPT Pipe thread (tapered)

d1= corresponds to the inside diameter of the hose

Available from: **MARYLAND METRICS** P.O. Box 261 Owings Mills, MD 21117 USA  
 ph: (410)358-3130 (800)638-1830 fx: (410)358-3142 (800)872-9329  
 web: <http://mdmetric.com> email: [sales@mdmetric.com](mailto:sales@mdmetric.com)

**Stainless steel Adaptors**

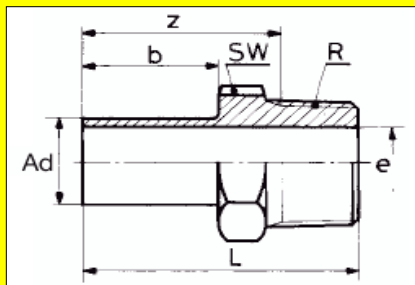

BSPT tube stub (standpipe) x male thread

Tapered adaptor thread Series: SO 51600

**BSPT Adjustable male adaptor**

| Type – Ad – R         | bar | S W | b    | L    | z    | e   | kg/100 | \$ each |
|-----------------------|-----|-----|------|------|------|-----|--------|---------|
| R950-SO 51600-A4-1/8  | 250 | 10  | 10   | 22   | 18   | 2,5 | 0,570  | \$8.52  |
| R950-SO 51600-A5-1/8  | 250 | 10  | 10,5 | 22,5 | 18,5 | 3,2 | 0,600  | \$8.88  |
| R950-SO 51600-A6-1/8  | 200 | 12  | 13   | 26   | 22   | 4   | 0,950  | \$8.67  |
| R950-SO 51600-A6-1/4  | 200 | 14  | 13   | 31   | 25   | 4   | 1,700  | \$9.74  |
| R950-SO 51600-A8-1/8  | 200 | 12  | 14   | 28   | 24   | 6   | 0,660  | \$9.74  |
| R950-SO 51600-A8-1/4  | 200 | 14  | 14   | 32   | 26   | 6   | 1,660  | \$9.74  |
| R950-SO 51600-A10-1/4 | 160 | 14  | 16   | 34   | 28   | 8   | 1,490  | \$11.82 |
| R950-SO 51600-A10-3/8 | 160 | 17  | 16   | 34   | 27,6 | 8   | 2,770  | \$14.11 |
| R950-SO 51600-A10-1/2 | 160 | 22  | 16   | 39   | 30,8 | 8   | 5,500  | \$17.98 |
| R950-SO 51600-A12-1/4 | 160 | 14  | 18   | 36   | 30   | 8   | 1,530  | \$16.48 |
| R950-SO 51600-A12-3/8 | 160 | 17  | 18   | 36   | 29,6 | 9   | 2,690  | \$16.33 |
| R950-SO 51600-A12-1/2 | 160 | 22  | 18   | 91   | 32,8 | 9   | 5,080  | \$20.06 |
| R950-SO 51600-A15-1/2 | 100 | 22  | 21   | 44   | 35,8 | 12  | 4,890  | \$20.06 |

R = BSPT Pipe thread (tapered)

Metric fine thread

**Hexagon jam/panel (thin) nut**

Series: SO 50006

| Type – M                 | SW | D    | h   | s   | kg/100 | \$ each |
|--------------------------|----|------|-----|-----|--------|---------|
| R950-SO 50006–M 6 x 0,75 | 10 | 9,8  | 0,5 | 3,5 | 0,170  | \$1.93  |
| R950-SO 50006–M 8 x 1    | 12 | 11,8 | 0,5 | 3,5 | 0,200  | \$1.93  |
| R950-SO 50006–M 10 x 1   | 14 | 13,8 | 0,5 | 5   | 0,360  | \$2.08  |
| R950-SO 50006–M 12 x 1   | 17 | 16,8 | 0,5 | 6   | 0,650  | \$2.29  |
| R950-SO 50006–M 14 x 1   | 19 | 18,8 | 0,5 | 6   | 0,750  | \$2.72  |
| R950-SO 50006–M 16 x 1   | 22 | 21,8 | 0,5 | 6   | 1,050  | \$3.51  |
| R950-SO 50006–M 20 x 1,5 | 27 | 26,8 | 0,5 | 6   | 1,430  | \$6.16  |
| R950-SO 50006–M 24 x 1,5 | 30 | 29,8 | 0,5 | 7   | 1,880  | \$9.10  |
| R950-SO 50006–M 28 x 1,5 | 36 | 35,8 | 0,5 | 8   | 3,260  | \$11.60 |

M = Metric fine thread

ver a04g

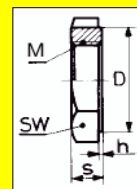

MARYLAND METRICS - Your one-stop METRIC HARDWARE source offers over 1,200,000 METRIC sized items from over 900 suppliers, worldwide: Fasteners, Hand Tools, Cutting Tools, Measuring Tools, Hydraulic & Pneumatic Fittings & Tubing, Oil Seals, O-rings, Bearings, Mechanical Power Transmission Equipment, Workholding Components, Metal Shapes, Plumbing Fittings, Electrical - Lamps, Fuses, Conduit Fittings & Cable. We also offer British sized (whitworth) fasteners & tools.